

BA015B25

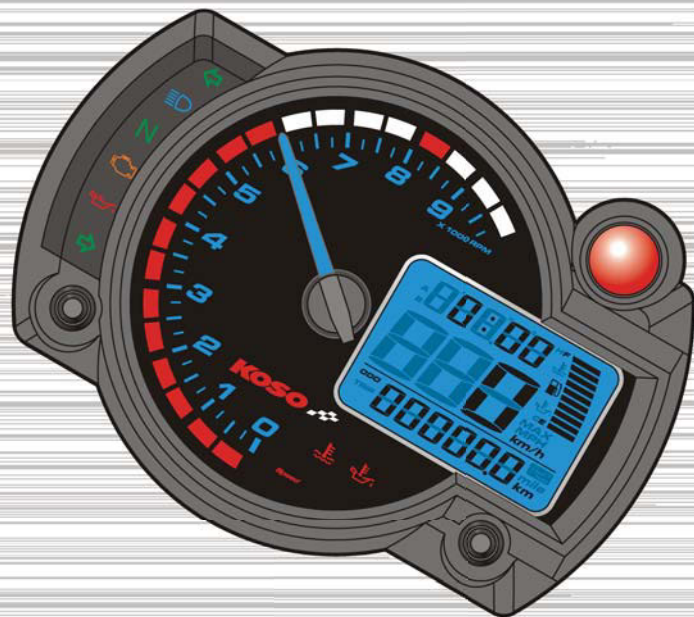

BA015B15





Thank you for purchasing KOSO RX2N GP style meter, before operating the unit, please read the Instruction thoroughly and retain it for the future reference.

Notice

1. The lcd meter is apply for DC 12V.
2. For installation, please follow the steps described in manual. Any damage caused by wrong installation shall be imputed to the users.
3. Don't break or modify the wire terminal. To avoid the short circuit, please don't pull the wire when installing.
4. Do not disassemble or change any parts excluding the manual description.
5. The interior examination or maintenance should be executed by our professionals.

MARK MEANING:

NOTE You could get the installation details from the information behind the mark.

△ Some processes must be followed to avoid the affection caused by wrong installation.

△ WARNING! Some processes must be followed to avoid damages to yourself or the public.

△ CAUTION! Some processes must be followed to avoid the damage to the vehicle.



Press the button one time



Press down the button for 3 seconds

Content

1-1	Accessory	Attachment
1-2	Option accessory	Attachment
2-1	Wiring Installation Instructions	Attachment
2-2	Installation Instructions	Attachment
3-1	Auto-checking screen	P04
3-2	Meter size	P05
3-3	Overview	P06
3-4	Function, setting instruction	P08

4-1	The button function instruction	P10
4-2	The screen switch instruction	P11
4-3	Select button function instruction	P12
4-4	Adjust button function instruction	P13
5	The setting screen instruction	P14
5-1	Speeding warning light setting	P16
5-2	The RPM shift light setting	P18
5-3	Over heat warning light (Water temperature) setting	P21
5-4	Over heat warning light (Oil temperature) setting	P23
5-5	The target speed timer / target distance timer setting	P25
5-6	Tire circumference and sensor point setting	P27
5-7	RPM Input pulse & signal impulse setting	P30
5-8	The fuel gauge resistance and insufficient fuel warning setting	P32
5-9	The clock setting	P34
5-10	The perpetual calendar setting	P36
5-11	The backlight brightness setting	P39
5-12	The real odometer record setting	P40
5-13	The displayed odometer setting	P41
6	The power test screen instruction	P43
6-1	Target speed timer test	P44
6-2	Target distance timer test	P46
6-3	The top speed test	P48
7	Trouble shooting	P50

△ We recommend that you finish the relative setting before operating to assure the operation of meter.

3-1 Auto-checking screen



Off



Check 5



Check 1



Check 6



Check 2



Check 7



Check 3



Check 8



Check 4



On

3-2 Meter size

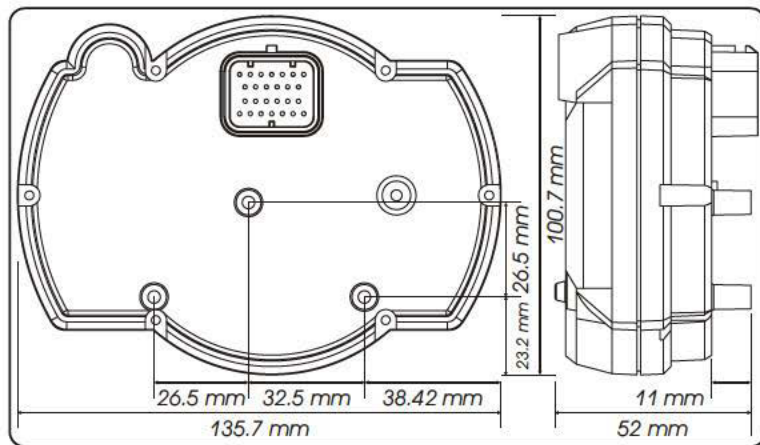

NOTE It will enter the setting screen automatically when the first time you start it.

The max RPM recall Indicator light

- The Indicator light will move according to the current RPM.
- The max RPM indicator light will show you the max RPM you reach and light on for 3 seconds.

Tachometer (10,000 RPM)

- Display unit: 250 RPM.
- ## Tachometer (20,000 RPM)
- Display unit: 500 RPM.



Tachometer (10,000 RPM)

- Display range: 0~10,000 RPM.
 - Display unit: 250 RPM.
- ## Tachometer (20,000 RPM)
- Display range: 0~20,000 RPM.
 - Display unit: 500 RPM.

Clock

- 24H



Digital thermometer (Water & oil temperature)

- Display range: 0~250°C (32~482°F)
- Display unit: 0.1°C (°F)



The RPM shift light (10,000 RPM)

- Setting range: 1,000~10,000 RPM.
 - Setting unit: 100 RPM.
- ## The RPM shift light (20,000 RPM)
- Setting range: 1,000~20,000 RPM.
 - Setting unit: 100 RPM.

Pre-Shift light

- Setting range: -500~-3,000 RPM before the shift light.
 - Setting unit: 100 RPM.
- > Regarding the setting, please check 5-2.

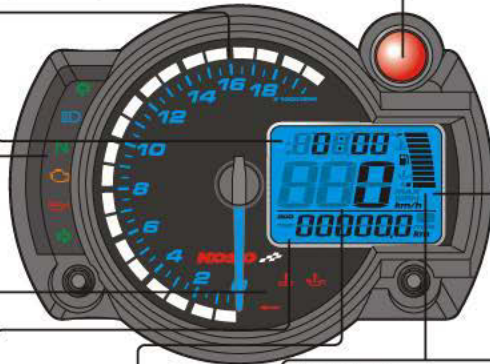

Max. record

- The meter will record the top speed, RPM and temperature automatically.



Speeding warning light

- Setting range: 30~360 km/h (20~225 MPH).
 - Setting unit: 1 km/h (MPH).
- > Regarding the setting, please check 5-1.



Over heat warning light (Water & oil temperature)

- Setting range: 60~250°C (140~482°F).
 - Setting unit: 1°C (°F).
- > Regarding the setting, please check 5-3.5-4.



Indicators lights

- Turn signal light (Green)
- High beam light (Blue)
- Neutral light (Green)
- EOBD light (Amber)
- Engine oil pressure light (Red)



Odo meter

- Display range: 0~99999.9 km (mile), reset automatically after 99999.9 km.
- Display unit: 0.1 km (mile).



Trip meter A.B

- Display range: 0~999.9 km (mile), reset automatically after 999.9 km.
- Display unit: 0.1 km (mile).



Speedometer

- Display range: 0~360 km/h (0~225 MPH)
 - Display unit: km/h & MPH for alternative.
- > Regarding the setting, please check 4-4.



Fuel meter

- Display range: 10 levels.
- Setting range: 100 Ω, 510 Ω, fuel switch, no display.

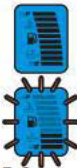

Fuel warning

- Setting range: 10~50 %
 - Setting unit: 10 %
- > Regarding the setting, please check 5-8.

Level thermometer (Water & oil temperature)

- Display range: 20~120°C (68~248°F), 10 levels.
- Display unit: Each level represents 10°C (50°F)



3-4 Function, setting Instruction

●Speedometer	Display range: 0~360 km/h (0~225 MPH) Display unit: km/h & MPH for alternative
○Display interval	<0.5 second
○Odometer	Display range: 0~99999.9 km (mile), reset automatically after 99999.9 km (mile).
○Trip meter A/B	Display range: 0~999.9 km (mile), reset automatically after 999.9 km (mile)
○Speeding warning light	Setting range: 30~360 km/h (20~225 MPH) Setting unit: 1 km/h (MPH)
○Top speed record	Display range: 0~360 km/h (0~225 MPH)
○Tire circumference	Setting range: 300~2,500 mm Setting unit: 1 mm • Sensitive point: 1~60 Points
●Tachometer	Display range: 0~10,000 / 20,000 RPM Display unit: 250 / 500 RPM
○Display interval	<0.5 second
○Shift light	Setting range: 1,000~10,000 / 20,000 RPM Setting unit: 100 RPM
○Pre-shift light	Setting range: -500~-3,000 RPM before the shift light Setting unit: 100 RPM
○Max. RPM record	Display range: 0~10,000 / 20,000 RPM
○RPM input pulse	Setting range: 0.5, 1, 1.5, 2, 2.5, 3, 4, 5, 6.
●Thermometer	Display unit: °C & °F for alternative
●Digital thermometer	Display range: 0~250°C (32~482°F) (Water & oil temperature) Display unit: 0.1°C (°F)
●Level thermometer	Display range: 20~120°C (68~248°F), 10 levels (Water & oil temperature) Display unit: Each level represents 10°C (50°F)
○Display interval	<0.5 second

○Over heat warning light	Setting range: 60~250°C (140~482°F) (Water & oil temperature) Setting unit: 1°C (°F)
○Top temperature record	Display range: 0~250°C (32~482°F)
●Fuel meter	Display range: 10 levels Display unit: Each level represents 10 % Setting range: 100 Ω, 510 Ω, fuel switch, no display
○Insufficient fuel warning	Setting range: 10~50 % Setting unit: 10 %
●Clock	24 H
●Perpetual calendar	Setting range: 2,000~2,099 A. D
●Target speed timer	Setting range: 30~360 km/h (20~225 MPH) Setting unit: 5 km/h (MPH)
●Target distance timer	Setting range: 1/32~20/32 mile (50~1,000 M) Setting unit: 1/32 mile (50 M)
●Top speed timer	The record including, 1.Speed: 0~360 km/h (0~225 MPH) 2.Distance: 0~999 M (0~3,280 feet) 3.RPM: 0~10,000 / 20,000RPM 4.Timer: 0~9'59"99 second.
●Effective voltage	DC 12 V
●Effective temperature range	-10~+60°C
●Meter standard	JIS D 0203 S2
●Meter size	135.7 X 100.7 X 52 mm
●Meter weight	Around 240 g
●Indicator light color	Neutral-green, High beam-blue, Turn signal-green, EOBD-amber, Oil-red, Speeding-red, RPM shift light yellow / red.

NOTE Design and specification are subject to change without notice!

4-1 The button function instruction

Select button

1. In main screen, press the **Select** button to choose the display of clock, water temperature or oil temperature.
2. In power test screen, press the **Select** button to choose the function you want to use.
3. In setting screen, press the **Select** button to choose the function you want to set.

Select button X 3 seconds

1. When the temperature is in the main screen, you could press down the "Select" button for 3 seconds to switch the temperature unit.
2. In power test screen, press down the **Select** button for 3 seconds to back to the main screen.
3. In setting screen, press down the **Select** button for 3 seconds to back to the main screen.



Adjust button

1. In main screen, press the **Adjust** button to choose the display of odometer, trip A, trip B or the Max. record.
2. In power test screen, press the **Adjust** button to reset the record, stop the testing, or restart the test.
3. In setting screen, press the **Adjust** button to make the setting. If you keep pressing down the **Adjust** button the setting number will increase fast.

Adjust button X 3 seconds

In main screen, press down the **Adjust** button for 3 seconds to reset the trip A, trip B, or the Max. Record.

Press down the Adjust button

In setting screen, to add the setting value fast.

Select & Adjust X 3 seconds

In main screen, press down the **Select & Adjust** buttons at the same time for 3 seconds to enter the setting screen.



CAUTION! For safety reason - you could adjust the setting or operate the function only when the bike is stop.

4-2 The screen switch instruction



Select & Adjust X3 S

Select X3 S



Select X3 S

Select & Adjust one time



In the setting screen, press down the **Select** button for 3 seconds to back to the main screen.

In main screen, press down the **Select & Adjust** button at the same time for 3 seconds to enter the setting screen.

In main screen, press the **Select & Adjust** button one time to enter the power test screen.

In power test screen, press down the **Select** button for 3 seconds to back to the main screen.



In any screen, you could press down the **Select** buttons for 3 seconds to back to the main screen.

4-3 Select button function instruction



In main screen, press the Select button to choose the function combination you want to display on the screen.
The alternative combination is as the circle we list:
clock+fuel gauge → water temperature+fuel gauge
water temperature+oil temperature level gauge → oil temperature+water temperature level gauge
temperature level gauge → clock+fuel gauge.

NOTE If you don't install the fuel wiring, the fuel gauge will not display.

- When the temperature is in the main screen, you could press down the "Select" button for 3 seconds to switch the temperature unit.



4-4 Adjust button function instruction



- In ODO function, press the Adjust button one time to switch to the trip A function.



- In trip A screen, press the Adjust button one time to switch to the trip B function.

- Press down the Adjust button for 3 seconds to reset the trip A.



- In trip B screen, press the Adjust button one time to switch to the Max. record function.

- Press down the Adjust button for 3 seconds to reset the trip B.



- In Max. record screen, press the Adjust button one time to switch to the ODO function.

- Press the Select button one time to check the oil temperature record.



- Press down the Adjust button for 3 seconds to reset the Max. record.



5 The setting screen Instruction

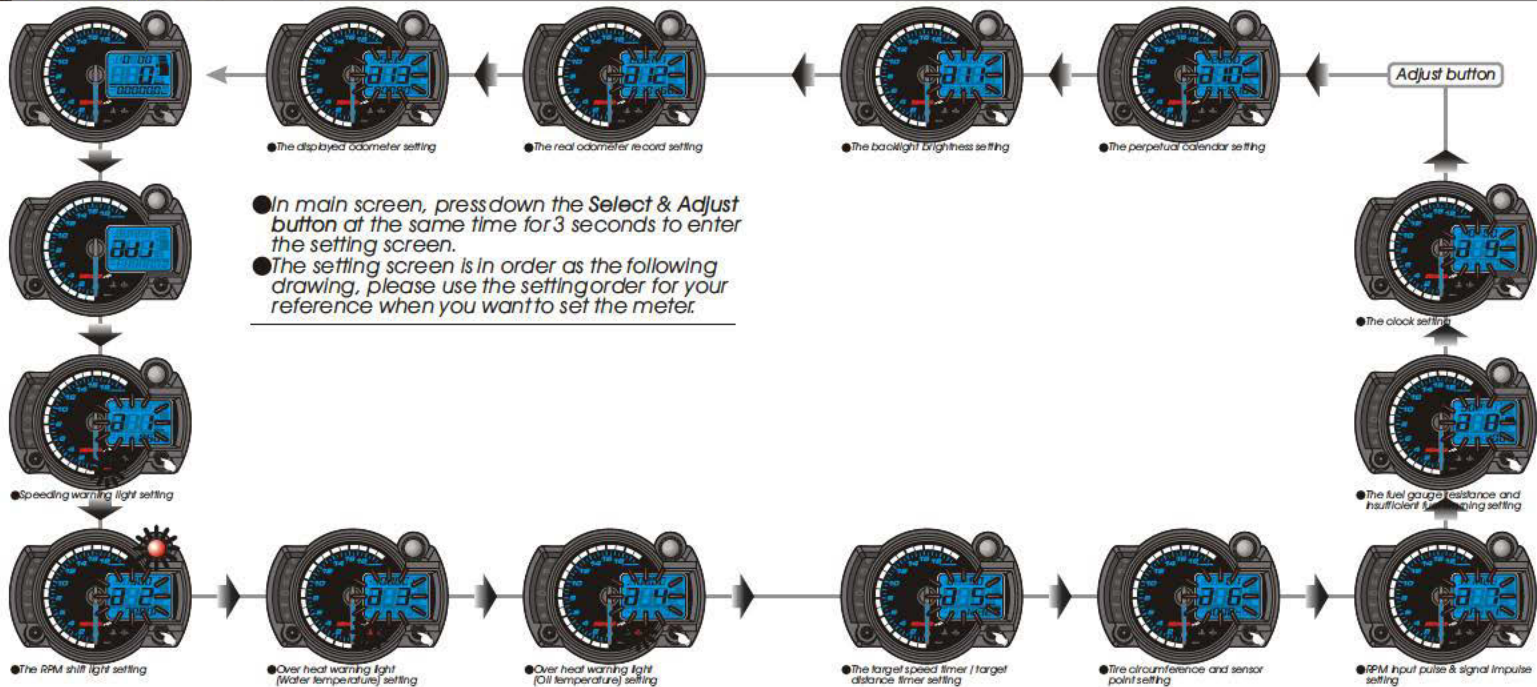

NOTE If you enter the setting screen for 30 seconds and don't press the button, it will back to the main screen automatically.

5-1 Speeding warning light setting



- In a 1 screen, press the Select button to enter the speeding warning light setting screen.
- EX. Now the speeding warning light setting is 60 km/h.

PS.



The speeding light will light on when the speed reaches your speeding warning setting.



- EX. The speeding warning light you want to set is 65 km/h.
- Press the Select button to move to the digit you want to set.



⚠ Now the speeding warning light and the setting value is flashing!

NOTE The speeding warning light setting range: 30~360km/h (20~225 MPH).
Setting unit: 1 km/h (MPH).

⚠ The setting unit will change together with the unit setting (4-4).

- Press the Adjust button to choose the setting value.



Next page



- Press the Select button to return to a 1 setting screen.
- EX. Now the setting is changed from 60 km/h to 65 km/h.

NOTE When you leave this screen, the setting is finished.



- Press the Adjust button to select the other setting screens.



If you just want to make this function setting, you could press down the Select button for 3 seconds to back to the main screen.

5-2 The RPM shift light setting



- In a 2 screen, press the Select button to enter the RPM shift light setting screen.
- EX. Now the RPM shift light setting is 7,000 RPM.

PS.



The red color shift light will light on according to the shift light setting number.



- EX. The RPM shift light you want to set is 12,000 RPM.
- Press the Adjust button to choose the setting value.



▲ Now the shift light and the setting value is flashing!

NOTE The setting range: 1,000~10,000 / 20,000 RPM.
Setting unit: 100 RPM.



- Press the Select button to enter the pre-shift light setting.
- EX. Now the shift light setting is changed from 7,000 RPM to 12,000 RPM.

Next page

PS.



The yellow color pre-shift light will light on according to the shift light setting number.



- EX. You want the pre-shift light to light on at 10,500 RPM
- The equation is as following.
The shift light setting value (12,000 RPM) - The pre-shift light setting value, (X) = 10,500 (The RPM you want the pre-shift light to light on.)
→ The setting value of pre-shift light = 1,500.
It means that you should set the pre-shift light setting as 1,500.
- Press the Adjust button to choose the setting value.



▲ Now the pre-light and the setting number is flashing!

NOTE The setting range: -500~-3,000 RPM.
Setting unit: 100 RPM.



- Press the Select button to return to a 2 setting screen.
- EX. Now the pre-shift light setting is changed from 500 RPM to 1,500 RPM.

NOTE When you leave this screen, the setting is finished.

Next page

5-2 The RPM shift light setting



- Press the Adjust button to select the other setting screens.

 If you just want to make this function setting, you could press down the Select button for 3 seconds to back to the main screen.

5-3 Over heat warning light (Water temperature) setting



- In a 3 screen, press the Select button to enter the over heat warning light (Water temperature) setting screen.
- EX. Now the over heat warning light (Water temperature) setting is 100.0°C.



- EX. You want to set the over-heat warning light (Water temperature) at 102.0°C.
- Press the Select button to move to the digit you want to set.



⚠ Now the water temperature logo and the setting value are flashing!

NOTE The over heat warning light setting range: 60~250°C (140~482°F).
Setting unit: 1°C (°F).

⚠ The setting unit will change together with the unit setting (4-4).



- Press the Adjust button to choose the setting value.



Next page

5-3 Over heat warning light (Water temperature) setting



- Press the **Select** button to return to a 3 setting screen.
- EX. Now the setting is changed from 100.0°C to 102.0°C.

NOTE When you leave this screen, the setting is finished.

- Press the **Adjust** button to select the other setting screens.

 If you just want to make this function setting, you could press down the **Select** button for 3 seconds to back to the main screen.



5-4 Over heat warning light (Oil temperature) setting



- In a 4 screen, press the **Select** button to enter the over heat warning light (Oil temperature) setting screen.
- EX. Now the over heat warning light (Oil temperature) setting is 100.0°C.

P.S.  *Try it!*

The over heat warning light (Oil temperature) will flash when the temperature reached your setting.



- EX. You want to set the over-heat warning light (Oil temperature) at 102.0°C.
- Press the **Select** button to move to the digit you want to set.



⚠ Now the water temperature logo and the setting value are flashing!

NOTE The over heat warning light setting range: 60~250°C (140~482°F).
Setting unit: 1°C (°F).

⚠ The setting unit will change together with the unit setting (4-4).

- Press the **Adjust** button to choose the setting value.



Next page

5-4 Over heat warning light (Oil temperature) setting



- Press the **Select** button to return to a 4 setting screen.
- EX. Now the setting is changed from 100.0°C to 102.0°C.

NOTE When you leave this screen, the setting is finished.

- Press the **Adjust** button to select the other setting screens.

 If you just want to make this function setting, you could press down the **Select** button for 3 seconds to back to the main screen.



5-5 The target speed timer / target distance timer setting



- In a 5 screen, press the **Select** button to enter the target speed timer and target distance timer setting screen.
- EX. Now the target speed timer setting is 0~50 km/h and the target distance timer setting is 1/32 mile (50 M).



- EX. You want to set the target speed timer setting at 0~110 km/h.
- Press the **Adjust** button to choose the setting value.



 Now the target speed value is flashing!

NOTE The target speed timer setting range: 30~360 km/h (20~225 MPH).
Setting unit: 5 km/h (MPH).



- Press the **Select** button to enter the target distance timer setting screen.
- EX. Now the target speed timer is changed from 0~50 km/h to 0~110 km/h.



- EX. You want to set the target distance timer setting at 2/32 mile (100M).
- Press the **Adjust** button to choose the setting value.



Next page

⚠ Now the target distance value is flashing!

NOTE The target distance timer setting range:
1/32~20/32 mile (50~1,000 M).
Setting unit: 1/32 mile (50M).



- Press the **Select** button to return to a 5 setting screen.
- EX. Now the target distance timer setting is changed from 1/32 mile (50 M) to 2/32 mile (100 M).

NOTE When you leave this screen, the setting is finished.



- Press the **Adjust** button to select the other setting screens.

 If you just want to make this function setting, you could press down the **Select** button for 3 seconds to back to the main screen.



- In a 6 screen, press the **Select** button to enter the tire circumference and sensor point setting screen.
- EX. Now the tire circumference setting is 1,000 mm, and the sensor point is 1.

⚠ **CAUTION!**

- Please measure the tire circumference.
- The speed displayed on the meter will be affected by the setting, please make sure the setting number is correct before you make the setting.

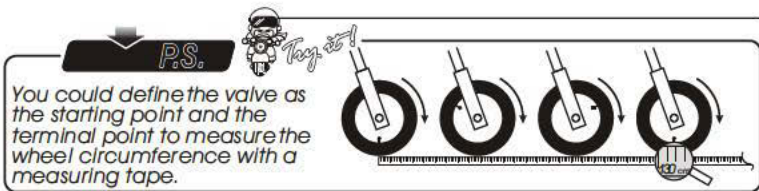

- EX. You want to set the circumference at 1,300 mm.
- Press the **Select** button to move to the digit you want to set.



⚠ Now the setting value is flashing!

NOTE The tire circumference setting range:
300~2,500 mm.
Setting unit: 1 mm.

5-6 Tire circumference and sensor point setting



- Press the **Adjust** button to choose the setting value.



- Press the **Select** button to enter the sensor point setting screen.
- EX. Now the circumference setting is changed from 1,000 mm to 1,300 mm.



- EX. The sensor point you want to set is 6.
- Press the **Select** button to move to the digit you want to set.



⚠ Now the sensor point setting value is flashing!

NOTE The sensor point setting range: 1~60 points.



- Press the **Adjust** button to choose the setting value.



- Press the **Select** button to return to a 6 setting screen.
- EX. Now the sensor point setting is changed from 1 to 6.

NOTE When you leave this screen, the setting is finished.



- Press the **Adjust** button to select the other setting screens.



If you just want to make this function setting, you could press down the **Select** button for 3 seconds to back to the main screen.

Next page



- In a 7 screen, press the **Select** button to enter the RPM Input pulse setting screen.
- EX. Now the RPM input pulse setting is 1 (4 Stroke, 2 piston) and the signal impulse setting is HI (The positive impulse).



- EX. You want to set the RPM Input pulse at 2 (4 Stroke, 4 piston).
- Press the **Adjust** button to choose the setting value.



▲ Now the setting number is flashing!

NOTE The RPM Input pulse setting range is : 0.5, 1, 1.5, 2, 2.5, 3, 4, 5, 6.

The setting value	The corresponding stroke and pistons number	The corresponding RPM signal number per ignition.
0.5	—	4C-1P 2 RPM signals per 1 Ignition.
1	2C-1P 4C-2P	1 RPM signal per 1 Ignition.
1.5	—	4C-3P 2 RPM signals per 3 Ignition.
2	2C-2P 4C-4P	1 RPM signal per 2 Ignition.
2.5	—	4C-5P 2 RPM signals per 5 Ignition.
3	2C-3P 4C-6P	1 RPM signal per 3 Ignition.
4	2C-4P 4C-8P	1 RPM signal per 4 Ignition.
5	—	4C-10P 2 RPM signals per 10 Ignition.
6	2C-6P 4C-12P	1 RPM signal per 6 Ignition.

▲ **CAUTION!** Most of the 4-cycle bikes with one single piston are igniting every 360 degree once, so the setting should be the same as the bike with 2-cycle and one piston engine.



- Press the **Select** button to enter the signal impulse setting screen.
- EX. Now the RPM input pulse setting is changed from 1 (4 Stroke, 2 piston) to 2 (4 Stroke, 4 piston).



- EX. The signal Impulse you want to set is Lo (The negative impulse).
- Press the **Adjust** button to choose the setting value.



NOTE The Impulse setting range is between HI (The positive impulse) & Lo (The negative impulse).

NOTE If the tachometer can't detect the signal (No RPM is displayed on the screen), you could choose another setting, and check it again.



- Press the **Select** button to return to a 7 setting screen.
- EX. Now the signal impulse setting is changed from HI P to Lo.

NOTE When you leave this screen, the setting is finished.



- Press the **Adjust** button to select the other setting screens.

If you just want to make this function setting, you could press down the **Select** button for 3 seconds to back to the main screen.



- In a 8 screen, press the Select button to enter the fuel gauge resistance and Insufficient fuel warning setting screen.
- EX. Now the fuel gauge resistance setting is 100 Ω and the Insufficient fuel warning setting is 30 %.

P.S.



Usually the fuel gauge resistance is 100 Ω on YAMAHA system, and 510 Ω on HONDA system.
The Insufficient fuel warning setting: When the fuel is less than your setting, the fuel level gauge will flash to warn you.



- EX. You want to change the fuel resistance setting to 510 Ω.
- Press the Adjust button to choose the setting value.



▲ Now the resistance setting value is flashing!

NOTE The fuel gauge resistance setting range : 100 Ω, 510 Ω, fuel switch.
The switch setting is for the fuel switch only, can't be used for the fuel level sensor.
If you don't install the fuel wiring, the fuel gauge will not display.



- Press the Select button to enter the Insufficient fuel warning setting screen.
- EX. Now the fuel gauge setting is changed from 100 Ω to 510 Ω.



- EX. You want to set the Insufficient fuel warning setting at 20 %.
- Press the Adjust button to choose the setting value.



▲ Now the Insufficient setting value is flashing!

NOTE The Insufficient fuel warning setting range: 10~50 %. Setting unit: 10 %.



- Press the Select button to return to a 8 setting screen.
- EX. Now the setting is changed from 30 % to 20 %.

NOTE When you leave this screen, the setting is finished.



- Press the Adjust button to select the other setting screens.

If you just want to make this function setting, you could press down the Select button for 3 seconds to back to the main screen.

Next page



- In a 9 screen, press the Select button to enter the clock setting screen.
- EX. Now the time is 0:00.



- EX. You want to set the clock at 12:05.
- Press the Adjust button to choose the setting value.



⚠ Now the hour value is flashing!

NOTE This is a 24 H clock.



- Press the Select button to enter the minute setting screen.
- EX. Now the hour is changed from 0 to 12.



- Press the Adjust button to choose the setting value.



⚠ Now the minute value is flashing!



- Press the Select button to return to a 9 setting screen.
- EX. Now the setting is changed from 0 to 5.

NOTE When you leave this screen, the setting is finished.



- Press the Adjust button to select the other setting screens.

 If you just want to make this function setting, you could press down the Select button for 3 seconds to back to the main screen.

Next page

5-10 The perpetual calendar setting



- In a 10 screen, press the **Select** button to enter the perpetual calendar setting screen.
- EX. Now the perpetual calendar setting is 2000/01/01 Saturday.



- EX. You want to set the perpetual calendar at 2009/07/17.
- Press the **Adjust** button to choose the setting value.



▲ Now the setting value is flashing!

NOTE If you choose to turn off the calendar function, press the **Select** button to return to a 10 screen. Then you could press the **Adjust** button to select other setting screens.



- Press the **Select** button to enter the year setting screen.



- Press the **Adjust** button to choose the setting value.



▲ Now the setting value is flashing!

Next page



- Press the **Select** button to enter the month setting screen.
- EX. Now the year setting is changed from 2000 to 2009.



- Press the **Adjust** button to choose the setting value.



▲ Now the setting value is flashing!

NOTE The month setting range: 1~12.

NOTE When you adjust the year and date, the day will adjust automatically.



- Press the **Select** button to enter the date setting screen.
- EX. Now the month setting is changed from 1 to 7.

Next page

5-10 The perpetual calendar setting



- Press the Adjust button to choose the setting value.



▲ Now the setting value is flashing!

NOTE The date setting range : 1~31.

NOTE When you adjust the year and date, the day will adjust automatically.



- Press the Select button to return to a 10 setting screen.
 - EX. Now the setting is changed from 01 to 17.
- NOTE** When you leave this screen, the setting is finished.



- Press the Adjust button to select the other setting screens.

 If you just want to make this function setting, you could press down the Select button for 3 seconds to back to the main screen.

5-11 The backlight brightness setting



- In a 11 screen, press the Select button to enter the backlight brightness setting screen.
- EX. Now the backlight brightness is 5 (The brightest setting).



- EX. You want to set the brightness at 3.
- Press the Adjust button to choose the setting value.



▲ Now the setting value is flashing!

NOTE The backlight brightness setting range : 1~5.

NOTE The brightness adjust setting is only effective in the LCD brightness.



- Press the Select button to return to a 11 setting screen.

- EX. Now the setting is changed from 5 to 3.

NOTE When you leave this screen, the setting is finished.



- Press the Adjust button to select the other setting screens.

 If you just want to make this function setting, you could press down the Select button for 3 seconds to back to the main screen.

5-12 The real odometer record setting



- The real odometer record is for you to check how long the meter already worked.
- In a 12 screen, press the Adjust button to select the other setting screens.
- EX. Now the real odometer record is 10,168 km.

⚠ The setting unit will change together with the unit setting (4-4).

5-13 The displayed odometer setting



- In a 13 screen, press the Select button to enter the displayed odometer setting setting screen.
- EX. Now the ODO is 0 km.



- EX. You want to set the displayed odometer as 3,000 km.
- Press the Select button to move to the digit you want to set.



⚠ Now the setting value is flashing!

NOTE The setting range: 0~99,999 km.
Setting unit: 1 km/h (MPH).



- Press the Adjust button to choose the setting value.



- Press the Select button to return to a 13 setting screen.
- EX. Now the setting is changed from 0 km to 3,000 km.

NOTE When you leave this screen, the setting is finished.

Next page

5-13 The displayed odometer setting



- Press the **Adjust** button to select the other setting screens.

 If you just want to make this function setting, you could press down the **Select** button for 3 seconds to back to the main screen.

6 The power test screen Instruction



- In main screen, press the **Select & Adjust** button one time to enter the power test screen.



- In power test screen, press the **Select** button to choose the test you want to do. The test function is in order as target speed timer, target distance timer, top speed timer.



- In power test screen, press the **Select** button to switch from the target speed timer to target distance timer.
- EX. Now it is in the target speed timer screen, and the setting is 0~110 km/h.



- In power test screen, press the **Select** button to switch from the target distance timer to the top speed timer screen.
- EX. Now the screen switch from the target speed timer screen to the target distance timer screen, and the setting is 2/32 mile (0~100 M).



- In power test screen, press the **Select** button to switch from the top speed timer to the target speed timer.
- EX. Now the screen switch from the target distance timer screen to the top speed timer screen.

6-1 Power TEST Target speed timer test



The record display screen



Enter the testing screen



Next page

⚠ WARNING!

Please use this function at racetrack to avoid traffic accidents.

- In power test screen, press the **Select** button one time to enter the target speed timer test screen.

NOTE Please start the test when the bike stops.

- ⚠ If you have the power test record, it will display the record first. You must clear the record before starting a new test.

- Press the **Adjust** button to clear the record and enter the target speed timer test screen.
- EX. Now you could see the record you have before. It displays the target speed timer setting as 0~110 km/h, the test result: 19'20 seconds. The top speed is 110 km/h during the test., The Max. RPM is 10,000 RPM during the test.

⚠ If you just want to check the record, you could press down the **Select** button for 3 seconds to back to the main screen.

- When the bike moves, the timer will start automatically.

⚠ Now the **TIME** is flashing!

NOTE About the power test setting, please check 5-5.

P.S.

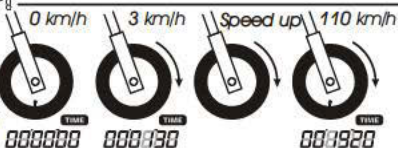

The timer is automatic, so when your bike start to move the timer will start to count the time and stop automatically after you stops the bike.

⚠ During the test, the **TIME** will keep flashing!



- When you reach the target speed you set (0~110 km/h), the timer will stop counting (19'20 second).

⚠ If you just want to use the function one time, press down the **Select** button for 3 seconds to save the records and back to the main screen.

- If you want to test it again, press the **Adjust** button to clear the record and enter the target speed timer test screen again.

P.S.

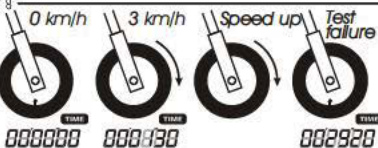

If you don't reach the target speed or stop accelerating during the test, you could press the **Adjust** button to stop the timer. Then you could press the **Adjust** button one time to clear the record and enter the target speed timer test screen.

6-2 Power TEST Target distance timer test



The record display screen



Enter the testing screen



Next page

⚠ WARNING!

Please use this function at racetrack to avoid traffic accidents.

- In power test screen, press the Select button 2 times to enter the target distance timer test screen.

NOTE Please start the test when the bike stops.

⚠ If you have the power test record, it will display the record first. You must clear the record before starting a new test.

- Press the Adjust button to clear the record and enter the target distance timer test screen.
- EX. Now you could see the record you have before. It displays the target speed timer setting as 2/32 mile (100 M), the test result: 10'27 seconds. The top speed is 63 km/h during the test., The Max. RPM is 8,000 RPM during the test.

ⓘ If you just want to check the record, you could press down the Select button for 3 seconds to back to the main screen.

- When the bike moves, the timer will start automatically.

⚠ Now the **TIME** is flashing!

NOTE About the power test setting, please check 5-5.



⚠ During the test, the **TIME** will keep flashing!



- When you reach the target distance you set (100 M . 2/32 mile), the timer will stop counting (10'27 second).

ⓘ If you just want to use the function one time, press down the Select button for 3 seconds to save the records and back to the main screen.

- If you want to test it again, press the Adjust button to clear the record and enter the target speed timer test screen again.

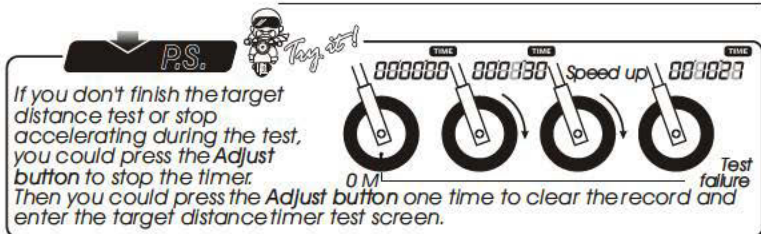

If you don't finish the target distance test or stop accelerating during the test, you could press the Adjust button to stop the timer. Then you could press the Adjust button one time to clear the record and enter the target distance timer test screen.

6-3 Power TEST The top speed test



The record display screen



Enter the testing screen



Next page

⚠ WARNING!

Please use this function at racetrack to avoid traffic accidents.

- In power test screen, press the Select button 3 times to enter the top speed test screen.

NOTE Please start the test when the bike stops.

- ⚠ If you have the power test record, it will display the record first. You must clear the record before starting a new test.

- Press the Adjust button to clear the record and enter the top speed test screen.
- EX. Now you could see the record you have before. It displays the top speed is 180 km/h, the distance to reach the top speed is 510 M, The Max. RPM is 10,000 RPM during the test, the time you need to reach the top speed is 10"20 seconds.

- ⚠ If you just want to check the record, you could press down the Select button for 3 seconds to back to the main screen.

- When the bike moves, the timer will start automatically.

- ⚠ Now the **TIME** is flashing!

NOTE The top speed test range:
 Speed: 0~360 km/h. Distance: 0~999 M (3280 feet) RPM: 0~10,000 / 20,000 RPM. Timer: 0~9'59"99 seconds.

- ⚠ The setting unit will change together with the unit setting (4-4).



- ⚠ During the test, the **TIME** will keep flashing!

- When you reach the top speed (180 km/h), the meter will stop counting the distance (510 M), and time (10"20 seconds).

- ⚠ If you just want to use the function one time, press down the Select button for 3 seconds to save the records and back to the main screen.

- If you want to test it again, press the Adjust button to clear the record and enter the target speed timer test screen again.

7 Trouble shooting

The following situation do not indicate malfunction of the meter.
Please check the following before taking it in for repair.

Trouble	Check Item
The meter doesn't work when the power is on.	<ul style="list-style-type: none">● The power doesn't supply to the meter. → Please make sure the wiring is connected. The wiring and fuse are not broken.→ The battery is broken or the battery is too old to supply enough power (DC 12V) to make the meter work.
The meter shows wrong information.	<ul style="list-style-type: none">● Please check the voltage of your battery, and make sure the voltage is over DC 12V.
Speed does not appear or appear incorrectly.	<ul style="list-style-type: none">● Please make sure the speed sensor is connected correctly.● Please check the tire-size setting. → please refer to the manual 5-6.
Tachometer does not appear or appear incorrectly.	<ul style="list-style-type: none">● Please check the RPM sensor wiring is connected correctly.● Please check the spark plug is R type or not. If not, please replace the spark plug with the R type spark plug.● Please check your setting. → Please refer to the manual 5-7.
Temp does not appear or appear incorrectly.	<ul style="list-style-type: none">● Please check the sensor. → Does the wiring break or falling off ?
Fuel gauge does not appear or appear incorrectly.	<ul style="list-style-type: none">● Please check your fuel tank. → Is there any fuel inside ?● Please check the wiring. → Do you connect the wiring correctly ?● Please check the setting. → Please refer to the manual 5-8.

Trouble	Check Item
The clock is incorrect. The odometer and trip meter is not accumulated or accumulated wrong data. When switch off, the needle doesn't return to 0.	<ul style="list-style-type: none">● It is possible that the positive wire is connected wrongly. → Please check is the red positive wire connect to the permanent power or battery and the brown positive wire is connected to the key on switch positive pole.● It is possible that the permanent power wire is not connected well. → Please check the red positive wire is connect well or not.

※If still can't solve the problems according to the steps above, please contact with distributors or us.